



# NPN SILICON HIGH FREQUENCY TRANSISTOR

## UPA807T

### FEATURES

- **SMALL PACKAGE STYLE:**  
2 NE686 Die in a 2 mm x 1.25 mm package
- **LOW NOISE FIGURE:**  
NF = 1.5 dB TYP at 2 GHz
- **HIGH GAIN:**  
 $IS_{21EI}^2 = 9$  dB TYP at 2 GHz
- **HIGH GAIN BANDWIDTH:**  $f_T = 13$  GHz
- **LOW CURRENT OPERATION**

### OUTLINE DIMENSIONS (Units in mm)

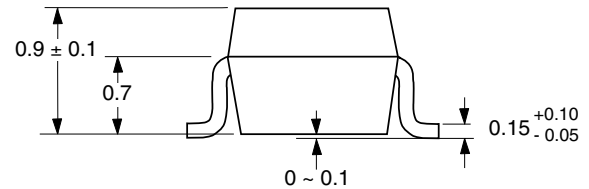
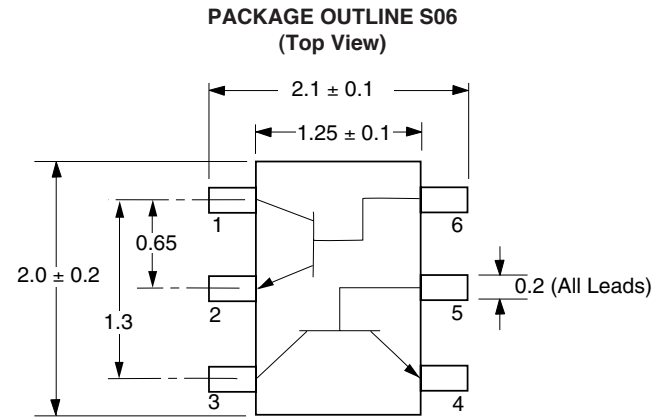

#### PIN OUT

1. Collector Transistor 1
2. Emitter Transistor 1
3. Collector Transistor 2
4. Emitter Transistor 2
5. Base Transistor 2
6. Base Transistor 1

#### Note:

Pin 3 is identified with a circle on the bottom of the package.

### DESCRIPTION

NEC's UPA807T is two NPN high frequency silicon epitaxial transistors encapsulated in an ultra small 6 pin SMT package. Each transistor is independently mounted and easily configured for either dual transistor or cascode operation. The high  $f_T$ , low voltage bias and small size make this device suited for various hand-held wireless applications.

### ELECTRICAL CHARACTERISTICS ( $T_A = 25^\circ\text{C}$ )

PART NUMBER PACKAGE OUTLINE			UPA807T S06		
SYMBOLS	PARAMETERS AND CONDITIONS	UNITS	MIN	TYP	MAX
$I_{CBO}$	Collector Cutoff Current at $V_{CB} = 5$ V, $I_E = 0$	$\mu\text{A}$			0.1
$I_{EBO}$	Emitter Cutoff Current at $V_{EB} = 1$ V, $I_C = 0$	$\mu\text{A}$			0.1
$h_{FE}^1$	Forward Current Gain at $V_{CE} = 2$ V, $I_C = 7$ mA		70	100	140
$f_T$	Gain Bandwidth at $V_{CE} = 2$ V, $I_C = 7$ mA, $f = 2$ GHz	GHz	10	13	
$C_{re}^2$	Feedback Capacitance at $V_{CB} = 2$ V, $I_E = 0$ , $f = 1$ MHz	pF		0.4	0.6
$IS_{21EI}^2$	Insertion Power Gain at $V_{CE} = 2$ V, $I_C = 7$ mA, $f = 2$ GHz	dB	7.5	9	
NF	Noise Figure at $V_{CE} = 2$ V, $I_C = 3$ mA, $f = 2$ GHz	dB		1.5	2
$h_{FE1}/h_{FE2}$	$h_{FE}$ Ratio: $h_{FE1} =$ Smaller Value of $Q_1$ , or $Q_2$ $h_{FE2} =$ Larger Value of $Q_1$ or $Q_2$		0.85		

Notes: 1. Pulsed measurement, pulse width  $\leq 350$   $\mu\text{s}$ , duty cycle  $\leq 2$  %.

2. The emitter terminal should be connected to the ground terminal of the 3 terminal capacitance bridge. For Tape and Reel version use part number UPA807T-T1, 3K per reel.

**ABSOLUTE MAXIMUM RATINGS<sup>1</sup>** (T<sub>A</sub> = 25°C)

SYMBOLS	PARAMETERS	UNITS	RATINGS
V <sub>CB0</sub>	Collector to Base Voltage	V	5
V <sub>CEO</sub>	Collector to Emitter Voltage	V	3
V <sub>EBO</sub>	Emitter to Base Voltage	V	2
I <sub>c</sub>	Collector Current	mA	10
P <sub>T</sub>	Total Power Dissipation		
	1 Die	mW	30
	2 Die	mW	60
T <sub>J</sub>	Junction Temperature	°C	150
T <sub>STG</sub>	Storage Temperature	°C	-65 to +150

Note: 1. Operation in excess of any one of these parameters may result in permanent damage.

**TYPICAL PERFORMANCE CURVES** (T<sub>A</sub> = 25°C)

**TOTAL POWER DISSIPATION vs. AMBIENT TEMPERATURE**

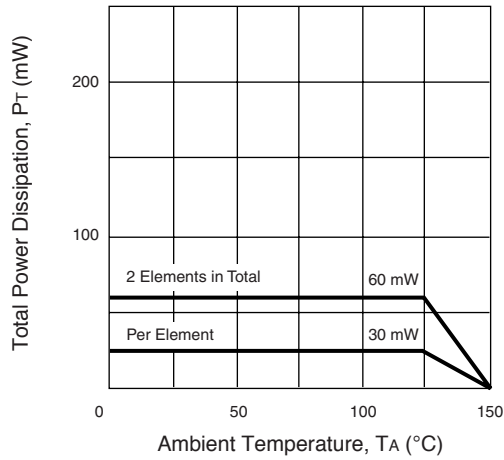

**COLLECTOR CURRENT vs. BASE TO EMITTER VOLTAGE**

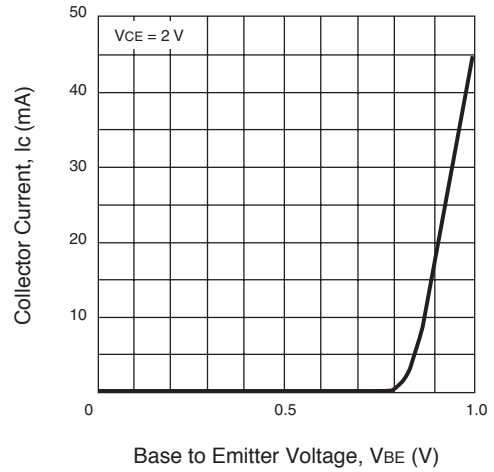

**COLLECTOR CURRENT vs. COLLECTOR TO EMITTER VOLTAGE**

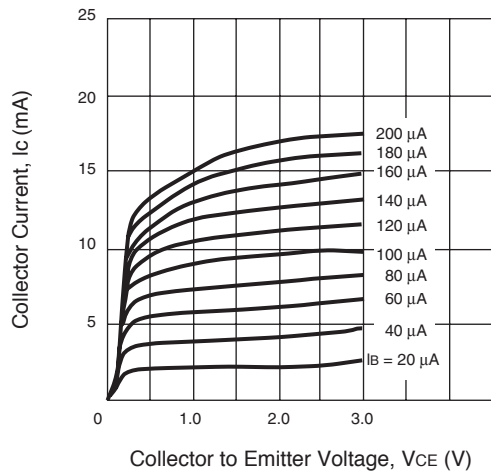

**DC CURRENT GAIN vs. COLLECTOR CURRENT**

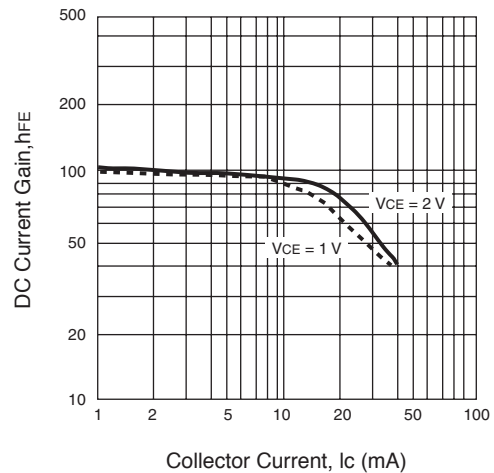

## TYPICAL PERFORMANCE CURVES ( $T_A = 25^\circ\text{C}$ )

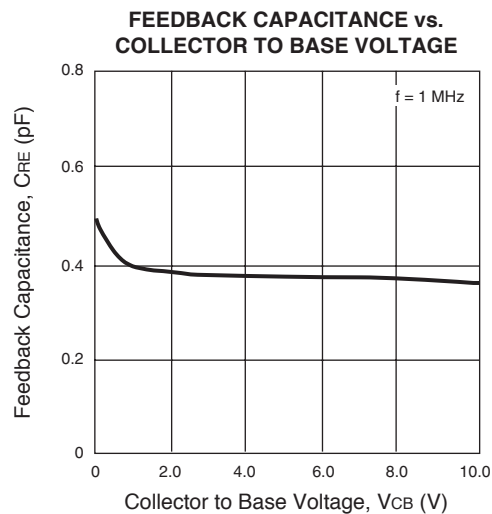
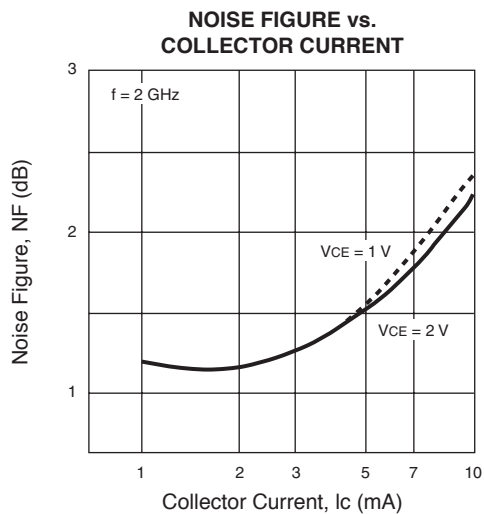
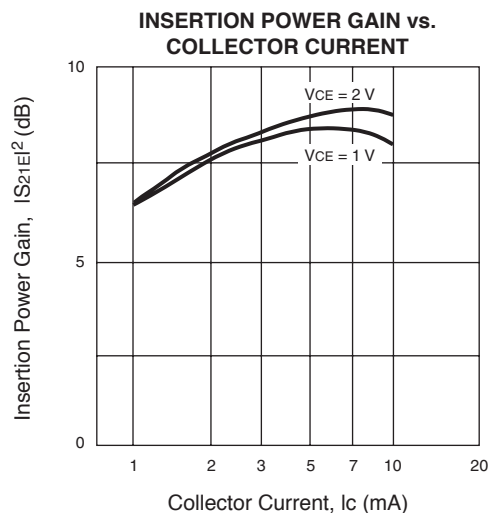
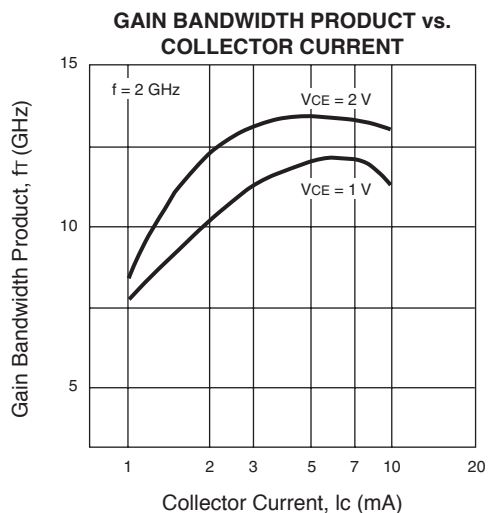

## ORDERING INFORMATION

PART NUMBER	QUANTITY	PACKAGING
UPA807T-T1-A	3000	Tape & Reel

**TYPICAL SCATTERING PARAMETERS** (T<sub>A</sub> = 25°C)

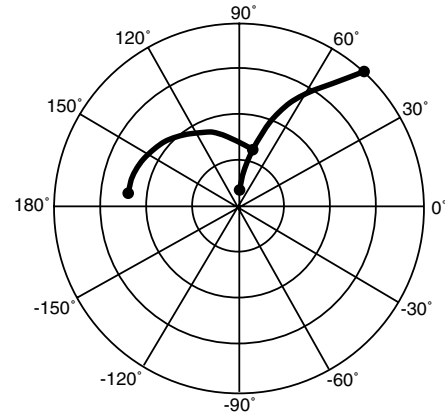
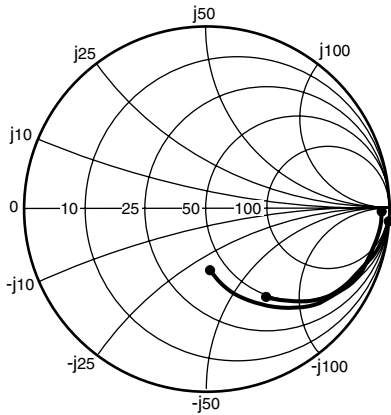

Coordinates in Ohms  
Frequency in GHz  
V<sub>CE</sub> = 1 V, I<sub>c</sub> = 1 mA

**UPA807T (Q1)**

V<sub>CE</sub> = 1 V, I<sub>c</sub> = 1 mA

FREQUENCY (GHz)	S <sub>11</sub>		S <sub>21</sub>		S <sub>12</sub>		S <sub>22</sub>		K	MAG (dB)
	MAG	ANG	MAG	ANG	MAG	ANG	MAG	ANG		
0.10	0.962	-1.96	3.029	171.72	0.018	87.63	0.990	-4.09	0.12	22.34
0.20	0.958	-8.94	3.004	168.23	0.035	82.52	0.984	-8.20	0.10	19.32
0.40	0.928	-18.56	2.938	157.25	0.068	74.99	0.960	-15.88	0.18	16.36
0.60	0.882	-27.04	2.842	147.17	0.097	68.55	0.924	-22.75	0.26	14.68
0.80	0.827	-35.09	2.709	137.91	0.121	62.88	0.883	-28.64	0.34	13.50
1.00	0.773	-42.12	2.535	129.87	0.141	58.23	0.843	-33.47	0.41	12.55
1.20	0.712	-48.31	2.414	122.20	0.157	54.56	0.801	-37.66	0.49	11.88
1.40	0.659	-53.74	2.271	115.57	0.170	51.59	0.768	-40.97	0.57	11.25
1.60	0.611	-58.52	2.136	109.66	0.181	49.24	0.735	-43.79	0.64	10.72
1.80	0.564	-62.92	2.027	104.33	0.192	47.40	0.714	-45.97	0.69	10.24
2.00	0.524	-66.81	1.917	99.44	0.200	45.99	0.687	-47.98	0.75	9.83
2.20	0.483	-70.60	1.820	94.75	0.208	44.89	0.670	-49.35	0.81	9.42
2.40	0.448	-73.91	1.757	90.45	0.214	44.05	0.645	-51.30	0.86	9.14
2.60	0.415	-77.47	1.688	86.67	0.223	43.32	0.630	-52.33	0.90	8.80
2.80	0.381	-80.66	1.628	82.67	0.229	42.65	0.613	-53.75	0.94	8.51
3.00	0.347	-83.65	1.585	79.07	0.236	42.57	0.591	-54.67	0.99	8.27

Note:

1. Gain Calculation:

$$MAG = \frac{|S_{21}|}{|S_{12}|} \left( K \pm \sqrt{K^2 - 1} \right). \text{ When } K \leq 1, \text{ MAG is undefined and MSG values are used. } MSG = \frac{|S_{21}|}{|S_{12}|}, K = \frac{1 + |\Delta|^2 - |S_{11}|^2 - |S_{22}|^2}{2 |S_{12} S_{21}|}, \Delta = S_{11} S_{22} - S_{21} S_{12}$$

MAG = Maximum Available Gain

MSG = Maximum Stable Gain

## TYPICAL SCATTERING PARAMETERS ( $T_A = 25^\circ\text{C}$ )

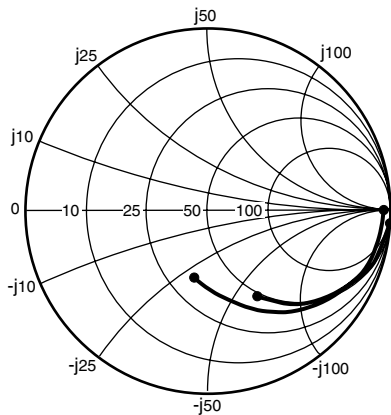

Coordinates in Ohms  
Frequency in GHz  
 $V_{CE} = 1\text{ V}$ ,  $I_C = 1\text{ mA}$

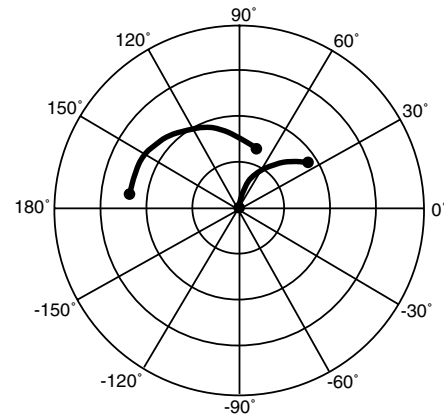

### UPA807T (Q2) $V_{CE} = 1\text{ V}$ , $I_C = 1\text{ mA}$

FREQUENCY (GHz)	S <sub>11</sub>		S <sub>21</sub>		S <sub>12</sub>		S <sub>22</sub>		K	MAG (dB)
	MAG	ANG	MAG	ANG	MAG	ANG	MAG	ANG		
0.10	0.962	-1.62	3.023	171.92	0.016	87.99	0.991	-3.62	0.12	22.83
0.20	0.961	-8.30	3.003	169.06	0.031	83.15	0.986	-7.34	0.09	19.80
0.40	0.935	-17.55	2.965	158.69	0.061	75.84	0.966	-14.42	0.17	16.84
0.60	0.894	-25.92	2.901	148.92	0.089	69.44	0.933	-20.98	0.25	15.15
0.80	0.843	-34.30	2.802	139.68	0.112	63.47	0.895	-26.92	0.32	13.97
1.00	0.792	-42.05	2.655	131.42	0.133	58.23	0.854	-32.14	0.39	13.01
1.20	0.730	-49.34	2.562	123.21	0.149	53.82	0.810	-36.91	0.47	12.35
1.40	0.675	-56.19	2.433	115.91	0.164	49.96	0.771	-40.99	0.54	11.72
1.60	0.624	-62.66	2.299	109.23	0.175	46.69	0.732	-44.55	0.61	11.18
1.80	0.574	-69.02	2.192	103.07	0.187	43.83	0.705	-47.64	0.66	10.70
2.00	0.533	-74.95	2.075	97.38	0.194	41.40	0.672	-50.59	0.72	10.29
2.20	0.493	-81.05	1.963	91.97	0.202	39.35	0.651	-52.80	0.78	9.87
2.40	0.462	-86.73	1.892	86.96	0.207	37.57	0.618	-55.53	0.83	9.60
2.60	0.435	-92.36	1.811	82.44	0.215	35.93	0.601	-57.47	0.87	9.26
2.80	0.410	-97.78	1.738	77.88	0.220	34.54	0.579	-59.60	0.92	8.98
3.00	0.385	-102.79	1.684	73.70	0.224	33.79	0.554	-61.25	0.96	8.76

Note:

1. Gain Calculation:

$$\text{MAG} = \frac{|S_{21}|}{|S_{12}|} \left( K \pm \sqrt{K^2 - 1} \right). \text{ When } K \leq 1, \text{ MAG is undefined and MSG values are used. } \text{MSG} = \frac{|S_{21}|}{|S_{12}|}, K = \frac{1 + |\Delta|^2 - |S_{11}|^2 - |S_{22}|^2}{2 |S_{12} S_{21}|}, \Delta = S_{11} S_{22} - S_{21} S_{12}$$

MAG = Maximum Available Gain

MSG = Maximum Stable Gain

**TYPICAL SCATTERING PARAMETERS** (TA = 25°C)

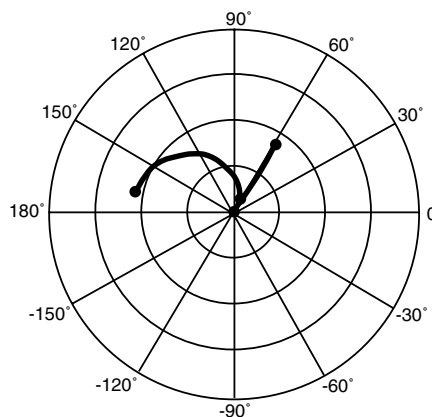
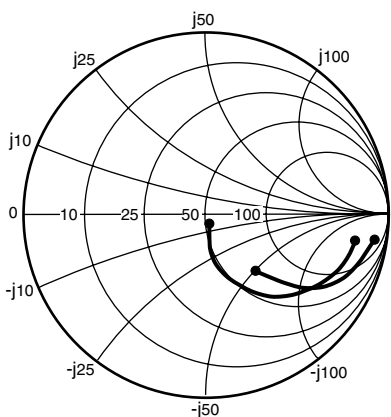

Coordinates in Ohms  
Frequency in GHz  
VCE = 1 V, IC = 5 mA

**UPA807T (Q1)**

VCE = 1 V, IC = 5 mA

FREQUENCY (GHz)	S11		S21		S12		S22		K	MAG (dB)
	MAG	ANG	MAG	ANG	MAG	ANG	MAG	ANG		
0.10	0.843	-10.23	11.043	167.54	0.017	83.02	0.955	-8.79	0.17	28.22
0.20	0.801	-22.30	10.550	156.06	0.032	76.32	0.913	-17.15	0.23	25.17
0.40	0.671	-41.12	9.111	136.87	0.056	67.09	0.793	-29.51	0.41	22.10
0.60	0.539	-54.78	7.622	122.59	0.073	62.22	0.683	-37.01	0.58	20.17
0.80	0.432	-64.35	6.368	112.11	0.087	60.06	0.601	-41.11	0.71	18.66
1.00	0.352	-71.08	5.396	104.18	0.099	59.29	0.545	-43.29	0.82	17.38
1.20	0.289	-75.50	4.664	97.80	0.110	59.27	0.506	-44.41	0.90	16.28
1.40	0.240	-78.43	4.095	92.46	0.121	59.38	0.481	-45.06	0.97	15.28
1.60	0.202	-80.40	3.653	87.93	0.132	59.61	0.464	-45.41	1.01	13.67
1.80	0.169	-80.85	3.293	83.81	0.144	59.70	0.454	-45.76	1.05	12.21
2.00	0.142	-80.11	3.000	80.15	0.155	59.82	0.446	-46.04	1.08	11.14
2.20	0.120	-78.17	2.763	76.75	0.167	59.82	0.441	-46.36	1.10	10.27
2.40	0.102	-74.75	2.561	73.55	0.179	59.77	0.435	-46.95	1.12	9.48
2.60	0.086	-70.60	2.390	70.71	0.191	59.58	0.431	-47.34	1.13	8.81
2.80	0.072	-64.00	2.245	67.87	0.203	59.26	0.427	-48.13	1.14	8.19
3.00	0.060	-54.64	2.120	65.23	0.215	58.85	0.421	-48.55	1.15	7.63

Note:

1. Gain Calculation:

$$MAG = \frac{|S_{21}|}{|S_{12}|} \left( K \pm \sqrt{K^2 - 1} \right). \text{ When } K \leq 1, \text{ MAG is undefined and MSG values are used. } MSG = \frac{|S_{21}|}{|S_{12}|}, K = \frac{1 + |\Delta|^2 - |S_{11}|^2 - |S_{22}|^2}{2 |S_{12} S_{21}|}, \Delta = S_{11} S_{22} - S_{21} S_{12}$$

MAG = Maximum Available Gain

MSG = Maximum Stable Gain

## TYPICAL SCATTERING PARAMETERS (T<sub>A</sub> = 25°C)

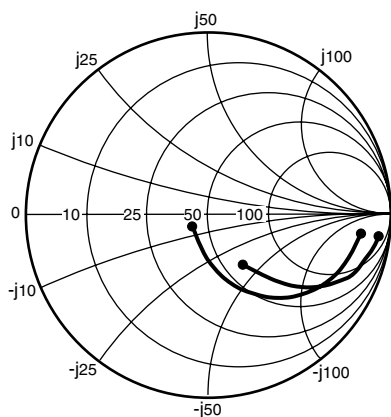

Coordinates in Ohms  
Frequency in GHz  
V<sub>CE</sub> = 1 V, I<sub>c</sub> = 5 mA

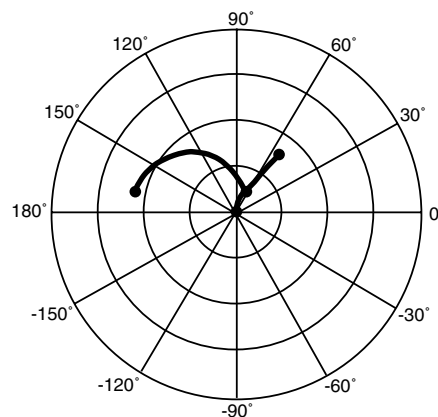

### UPA807T (Q2)

V<sub>CE</sub> = 1 V, I<sub>c</sub> = 5 mA

FREQUENCY (GHz)	S <sub>11</sub>		S <sub>21</sub>		S <sub>12</sub>		S <sub>22</sub>		K	MAG (dB)
	MAG	ANG	MAG	ANG	MAG	ANG	MAG	ANG		
0.10	0.845	-9.27	11.074	168.45	0.015	83.57	0.959	-7.84	0.16	28.73
0.20	0.809	-20.93	10.667	157.61	0.029	77.02	0.923	-15.57	0.22	25.67
0.40	0.693	-39.56	9.418	138.92	0.052	67.56	0.813	-27.50	0.39	22.61
0.60	0.565	-54.11	8.044	124.38	0.068	61.85	0.703	-35.26	0.55	20.73
0.80	0.456	-65.39	6.815	113.27	0.081	58.78	0.616	-39.97	0.69	19.26
1.00	0.373	-74.54	5.823	104.66	0.092	57.19	0.551	-42.88	0.79	18.02
1.20	0.305	-82.21	5.060	97.61	0.102	56.47	0.502	-44.74	0.88	16.95
1.40	0.254	-89.32	4.457	91.64	0.112	55.99	0.467	-46.16	0.95	15.98
1.60	0.214	-96.11	3.972	86.49	0.123	55.83	0.440	-47.03	1.01	14.55
1.80	0.182	-103.22	3.587	81.84	0.133	55.39	0.422	-48.16	1.05	12.97
2.00	0.158	-110.12	3.269	77.64	0.143	55.08	0.407	-49.09	1.08	11.86
2.20	0.139	-117.27	3.007	73.69	0.153	54.70	0.394	-50.04	1.10	10.95
2.40	0.126	-123.65	2.782	70.00	0.164	54.32	0.382	-50.96	1.13	10.13
2.60	0.116	-130.48	2.596	66.66	0.174	53.75	0.375	-51.87	1.14	9.46
2.80	0.108	-136.70	2.435	63.35	0.185	53.09	0.367	-52.94	1.15	8.83
3.00	0.102	-142.34	2.295	60.18	0.196	52.40	0.358	-53.58	1.16	8.25

Note:

1. Gain Calculation:

$$\text{MAG} = \frac{|S_{21}|}{|S_{12}|} \left( K \pm \sqrt{K^2 - 1} \right). \text{ When } K \leq 1, \text{ MAG is undefined and MSG values are used. } \text{MSG} = \frac{|S_{21}|}{|S_{12}|}, K = \frac{1 + |\Delta|^2 - |S_{11}|^2 - |S_{22}|^2}{2 |S_{12} S_{21}|}, \Delta = S_{11} S_{22} - S_{21} S_{12}$$

MAG = Maximum Available Gain

MSG = Maximum Stable Gain

**TYPICAL SCATTERING PARAMETERS** (TA = 25°C)

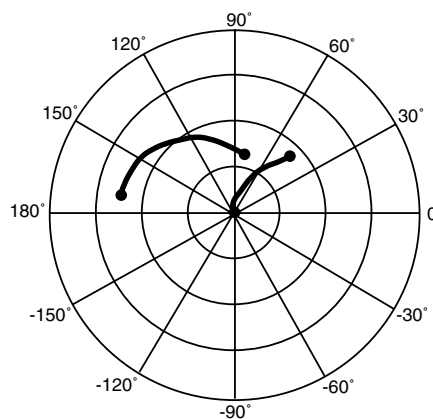
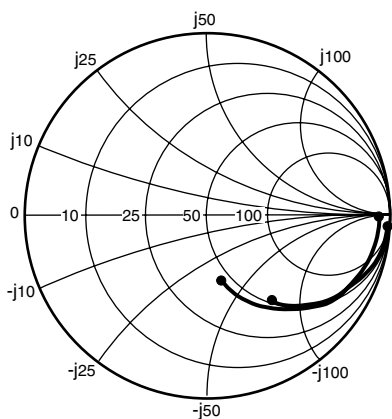

Coordinates in Ohms  
Frequency in GHz  
VCE = 2 V, IC = 1 mA

**UPA807T (Q1)**

VCE = 2 V, IC = 1 mA

FREQUENCY (GHz)	S11		S21		S12		S22		K	MAG (dB)
	MAG	ANG	MAG	ANG	MAG	ANG	MAG	ANG		
0.10	0.963	-1.86	3.046	171.80	0.016	87.84	0.991	-3.80	0.11	22.80
0.20	0.962	-8.32	3.022	168.73	0.032	82.94	0.986	-7.62	0.10	19.79
0.40	0.934	-17.28	2.964	158.29	0.061	75.87	0.964	-14.81	0.17	16.84
0.60	0.892	-25.24	2.877	148.61	0.088	69.78	0.931	-21.30	0.25	15.15
0.80	0.840	-32.80	2.752	139.68	0.110	64.35	0.894	-26.89	0.33	13.97
1.00	0.789	-39.43	2.583	131.90	0.129	59.87	0.856	-31.54	0.40	13.01
1.20	0.732	-45.25	2.469	124.40	0.144	56.36	0.817	-35.54	0.48	12.34
1.40	0.680	-50.38	2.330	117.91	0.157	53.50	0.784	-38.74	0.55	11.71
1.60	0.633	-54.84	2.195	112.11	0.167	51.24	0.753	-41.45	0.62	11.18
1.80	0.587	-58.98	2.089	106.89	0.178	49.49	0.732	-43.58	0.68	10.70
2.00	0.548	-62.56	1.976	102.08	0.185	48.15	0.706	-45.50	0.74	10.27
2.20	0.507	-66.04	1.878	97.47	0.193	47.15	0.690	-46.81	0.79	9.87
2.40	0.473	-69.01	1.813	93.28	0.200	46.45	0.665	-48.58	0.85	9.58
2.60	0.440	-72.16	1.745	89.51	0.208	45.81	0.651	-49.56	0.89	9.24
2.80	0.407	-74.98	1.682	85.66	0.215	45.27	0.633	-50.88	0.93	8.94
3.00	0.373	-77.40	1.639	82.07	0.221	45.24	0.613	-51.66	0.98	8.69

Note:

1. Gain Calculation:

$$MAG = \frac{|S_{21}|}{|S_{12}|} (K \pm \sqrt{K^2 - 1})$$

When  $K \leq 1$ , MAG is undefined and MSG values are used.  $MSG = \frac{|S_{21}|}{|S_{12}|}$ ,  $K = \frac{1 + |\Delta|^2 - |S_{11}|^2 - |S_{22}|^2}{2 |S_{12} S_{21}|}$ ,  $\Delta = S_{11} S_{22} - S_{21} S_{12}$

MAG = Maximum Available Gain

MSG = Maximum Stable Gain



## TYPICAL SCATTERING PARAMETERS $(T_A = 25^\circ\text{C})$

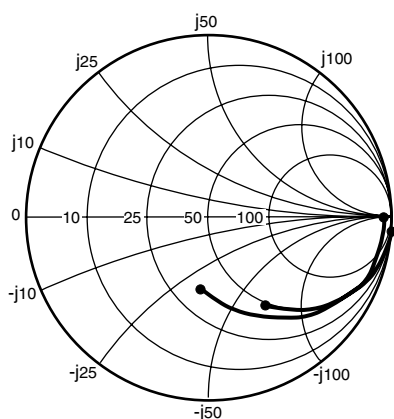

Coordinates in Ohms  
Frequency in GHz  
 $V_{CE} = 2\text{ V}$ ,  $I_c = 1\text{ mA}$

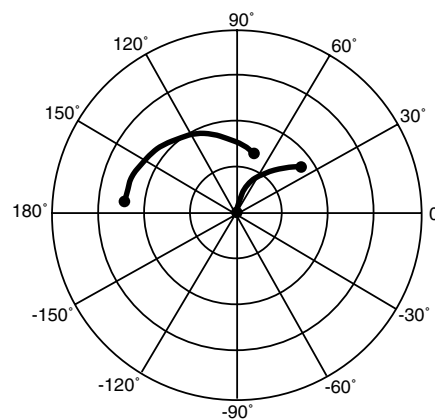

### UPA807T (Q2)

$V_{CE} = 2\text{ V}$ ,  $I_c = 1\text{ mA}$

FREQUENCY (GHz)	S <sub>11</sub>		S <sub>21</sub>		S <sub>12</sub>		S <sub>22</sub>		K	MAG (dB)
	MAG	ANG	MAG	ANG	MAG	ANG	MAG	ANG		
0.10	0.964	-1.52	3.044	171.97	0.014	88.24	0.992	-3.33	0.12	23.37
0.20	0.964	-7.70	3.022	169.57	0.028	83.48	0.988	-6.75	0.09	20.34
0.40	0.940	-16.26	2.990	159.76	0.055	76.78	0.970	-13.31	0.16	17.37
0.60	0.903	-24.04	2.934	150.43	0.079	70.76	0.941	-19.44	0.24	15.68
0.80	0.856	-31.89	2.845	141.56	0.101	65.08	0.906	-25.03	0.31	14.49
1.00	0.808	-39.13	2.705	133.59	0.120	60.07	0.868	-30.01	0.38	13.53
1.20	0.750	-45.98	2.621	125.61	0.135	55.84	0.827	-34.52	0.46	12.87
1.40	0.697	-52.41	2.498	118.52	0.149	52.12	0.790	-38.45	0.53	12.24
1.60	0.648	-58.51	2.367	111.95	0.160	48.96	0.753	-41.87	0.60	11.70
1.80	0.598	-64.46	2.267	105.93	0.171	46.21	0.726	-44.89	0.65	11.23
2.00	0.558	-70.00	2.148	100.30	0.178	43.86	0.694	-47.73	0.71	10.80
2.20	0.517	-75.73	2.036	94.95	0.186	41.88	0.674	-49.87	0.76	10.39
2.40	0.485	-80.95	1.964	90.03	0.192	40.24	0.642	-52.42	0.82	10.11
2.60	0.457	-86.26	1.884	85.50	0.199	38.68	0.625	-54.29	0.86	9.77
2.80	0.431	-91.31	1.808	81.05	0.204	37.39	0.603	-56.31	0.91	9.49
3.00	0.405	-95.89	1.754	76.84	0.208	36.69	0.579	-57.85	0.95	9.25

Note:

1. Gain Calculation:

$$\text{MAG} = \frac{|S_{21}|}{|S_{12}|} \left( K \pm \sqrt{K^2 - 1} \right). \text{ When } K \leq 1, \text{ MAG is undefined and MSG values are used. } \text{MSG} = \frac{|S_{21}|}{|S_{12}|}, K = \frac{1 + |\Delta|^2 - |S_{11}|^2 - |S_{22}|^2}{2 |S_{12} S_{21}|}, \Delta = S_{11} S_{22} - S_{21} S_{12}$$

MAG = Maximum Available Gain

MSG = Maximum Stable Gain

TYPICAL SCATTERING PARAMETERS (T<sub>A</sub> = 25°C)

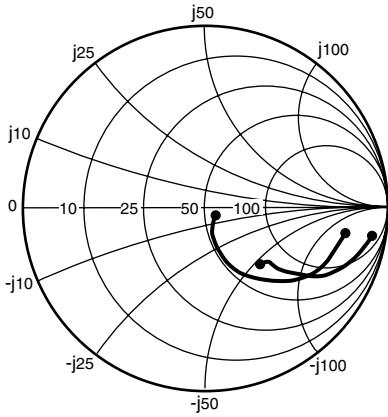

Coordinates in Ohms  
Frequency in GHz  
V<sub>CE</sub> = 2 V, I<sub>c</sub> = 7 mA

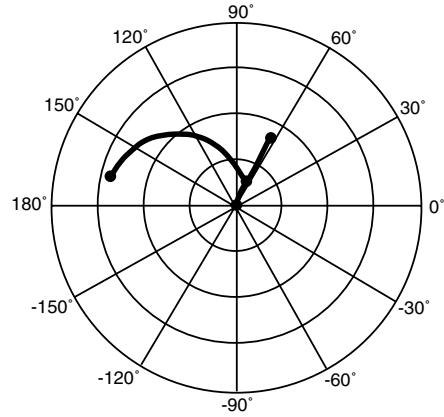

UPA807T (Q1)  
V<sub>CE</sub> = 2 V, I<sub>c</sub> = 7 mA

FREQUENCY (GHz)	S <sub>11</sub>		S <sub>21</sub>		S <sub>12</sub>		S <sub>22</sub>		K	MAG (dB)
	MAG	ANG	MAG	ANG	MAG	ANG	MAG	ANG		
0.10	0.805	-11.77	13.775	166.06	0.014	82.53	0.955	-9.08	0.18	29.79
0.20	0.754	-24.34	12.965	153.40	0.028	76.07	0.903	-17.39	0.28	26.73
0.40	0.607	-43.28	10.749	133.10	0.048	67.97	0.770	-28.70	0.48	23.53
0.60	0.473	-55.82	8.690	118.92	0.062	64.39	0.659	-34.59	0.66	21.45
0.80	0.372	-63.72	7.108	108.93	0.075	63.30	0.585	-37.22	0.79	19.79
1.00	0.299	-68.64	5.946	101.48	0.086	63.17	0.538	-38.37	0.88	18.39
1.20	0.244	-71.13	5.093	95.54	0.097	63.46	0.508	-38.84	0.95	17.18
1.40	0.201	-71.73	4.442	90.57	0.109	63.67	0.490	-39.13	1.00	15.69
1.60	0.169	-71.23	3.943	86.36	0.120	63.90	0.478	-39.31	1.04	13.92
1.80	0.143	-68.54	3.538	82.53	0.131	63.94	0.472	-39.62	1.07	12.70
2.00	0.123	-64.48	3.212	79.11	0.143	63.96	0.469	-39.95	1.09	11.70
2.20	0.108	-59.14	2.947	75.98	0.154	63.85	0.466	-40.33	1.10	10.85
2.40	0.099	-52.53	2.722	73.02	0.166	63.75	0.464	-40.96	1.12	10.08
2.60	0.090	-45.90	2.533	70.41	0.177	63.47	0.462	-41.40	1.12	9.41
2.80	0.085	-38.03	2.374	67.79	0.189	63.13	0.459	-42.20	1.13	8.79
3.00	0.081	-29.31	2.235	65.37	0.201	62.72	0.456	-42.63	1.14	8.23

Note:

1. Gain Calculation:

$$MAG = \frac{|S_{21}|}{|S_{12}|} (K \pm \sqrt{K^2 - 1})$$

When  $K \leq 1$ , MAG is undefined and MSG values are used.  $MSG = \frac{|S_{21}|}{|S_{12}|}$ ,  $K = \frac{1 + |\Delta|^2 - |S_{11}|^2 - |S_{22}|^2}{2 |S_{12} S_{21}|}$ ,  $\Delta = S_{11} S_{22} - S_{21} S_{12}$

MAG = Maximum Available Gain

MSG = Maximum Stable Gain

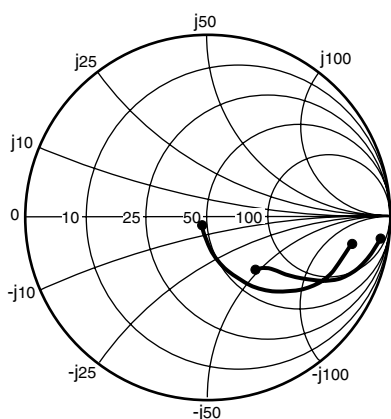
TYPICAL SCATTERING PARAMETERS ( $T_A = 25^\circ\text{C}$ )

Coordinates in Ohms  
Frequency in GHz  
 $V_{CE} = 2\text{ V}$ ,  $I_C = 7\text{ mA}$

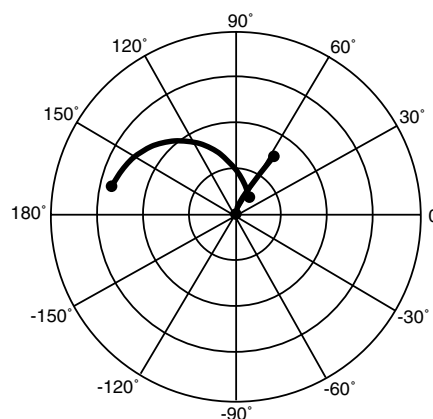

## UPA807T (Q2)

$V_{CE} = 2\text{ V}$ ,  $I_C = 7\text{ mA}$

FREQUENCY (GHz)	S11		S21		S12		S22		K	MAG (dB)
	MAG	ANG	MAG	ANG	MAG	ANG	MAG	ANG		
0.10	0.809	-10.62	13.836	167.10	0.013	83.43	0.959	-8.02	0.18	30.35
0.20	0.764	-22.77	13.157	155.16	0.025	76.87	0.915	-15.61	0.26	27.29
0.40	0.630	-41.69	11.201	135.28	0.043	68.25	0.793	-26.53	0.46	24.14
0.60	0.498	-55.31	9.243	120.72	0.057	63.92	0.683	-32.68	0.63	22.11
0.80	0.394	-65.19	7.659	110.07	0.068	61.99	0.602	-35.85	0.76	20.50
1.00	0.315	-72.82	6.455	101.95	0.079	61.19	0.547	-37.57	0.87	19.14
1.20	0.255	-78.94	5.555	95.38	0.089	60.93	0.507	-38.62	0.94	17.97
1.40	0.209	-84.50	4.862	89.82	0.099	60.70	0.480	-39.50	1.00	16.92
1.60	0.173	-89.77	4.312	85.02	0.109	60.62	0.459	-40.04	1.04	14.72
1.80	0.144	-95.21	3.880	80.67	0.119	60.22	0.445	-40.98	1.07	13.49
2.00	0.122	-100.74	3.525	76.72	0.130	59.84	0.435	-41.88	1.09	12.47
2.20	0.105	-106.37	3.233	73.03	0.140	59.38	0.425	-42.81	1.11	11.59
2.40	0.093	-111.55	2.983	69.57	0.150	58.94	0.416	-43.74	1.13	10.79
2.60	0.084	-117.18	2.776	66.44	0.161	58.29	0.412	-44.70	1.14	10.12
2.80	0.077	-122.47	2.599	63.32	0.171	57.59	0.406	-45.80	1.14	9.50
3.00	0.071	-127.14	2.445	60.36	0.182	56.86	0.400	-46.51	1.15	8.92

Note:

1. Gain Calculation:

$$\text{MAG} = \frac{|S_{21}|}{|S_{12}|} \left( K \pm \sqrt{K^2 - 1} \right). \text{ When } K \leq 1, \text{ MAG is undefined and MSG values are used. } \text{MSG} = \frac{|S_{21}|}{|S_{12}|}, K = \frac{1 + |\Delta|^2 - |S_{11}|^2 - |S_{22}|^2}{2 |S_{12} S_{21}|}, \Delta = S_{11} S_{22} - S_{21} S_{12}$$

MAG = Maximum Available Gain

MSG = Maximum Stable Gain

## Life Support Applications

These NEC products are not intended for use in life support devices, appliances, or systems where the malfunction of these products can reasonably be expected to result in personal injury. The customers of CEL using or selling these products for use in such applications do so at their own risk and agree to fully indemnify CEL for all damages resulting from such improper use or sale.

EXCLUSIVE NORTH AMERICAN AGENT FOR **NEC** RF, MICROWAVE & OPTOELECTRONIC SEMICONDUCTORS

**CEL** CALIFORNIA EASTERN LABORATORIES • Headquarters • 4590 Patrick Henry Drive • Santa Clara, CA 95054-1817 • (408) 988-3500 • Telex 34-6393 • FAX (408) 988-0279  
24-Hour Fax-On-Demand: 800-390-3232 (U.S. and Canada only) • Internet: <http://WWW.CEL.COM>

DATA SUBJECT TO CHANGE WITHOUT NOTICE

PRINTED IN USA ON RECYCLED PAPER -12/98

Subject: Compliance with EU Directives

CEL certifies, to its knowledge, that semiconductor and laser products detailed below are compliant with the requirements of European Union (EU) Directive 2002/95/EC Restriction on Use of Hazardous Substances in electrical and electronic equipment (RoHS) and the requirements of EU Directive 2003/11/EC Restriction on Penta and Octa BDE.

CEL Pb-free products have the same base part number with a suffix added. The suffix –A indicates that the device is Pb-free. The –AZ suffix is used to designate devices containing Pb which are exempted from the requirement of RoHS directive (\*). In all cases the devices have Pb-free terminals. All devices with these suffixes meet the requirements of the RoHS directive.

This status is based on CEL’s understanding of the EU Directives and knowledge of the materials that go into its products as of the date of disclosure of this information.

Restricted Substance per RoHS	Concentration Limit per RoHS (values are not yet fixed)	Concentration contained in CEL devices	
		-A	-AZ
Lead (Pb)	< 1000 PPM	Not Detected	(*)
Mercury	< 1000 PPM	Not Detected	
Cadmium	< 100 PPM	Not Detected	
Hexavalent Chromium	< 1000 PPM	Not Detected	
PBB	< 1000 PPM	Not Detected	
PBDE	< 1000 PPM	Not Detected	

If you should have any additional questions regarding our devices and compliance to environmental standards, please do not hesitate to contact your local representative.

Important Information and Disclaimer: Information provided by CEL on its website or in other communications concerning the substance content of its products represents knowledge and belief as of the date that it is provided. CEL bases its knowledge and belief on information provided by third parties and makes no representation or warranty as to the accuracy of such information. Efforts are underway to better integrate information from third parties. CEL has taken and continues to take reasonable steps to provide representative and accurate information but may not have conducted destructive testing or chemical analysis on incoming materials and chemicals. CEL and CEL suppliers consider certain information to be proprietary, and thus CAS numbers and other limited information may not be available for release.

In no event shall CEL’s liability arising out of such information exceed the total purchase price of the CEL part(s) at issue sold by CEL to customer on an annual basis.

See CEL Terms and Conditions for additional clarification of warranties and liability.